

REV.	DESCRIPTION	DATE	DWN	APVD
A	-	27SEP08	JC	BC

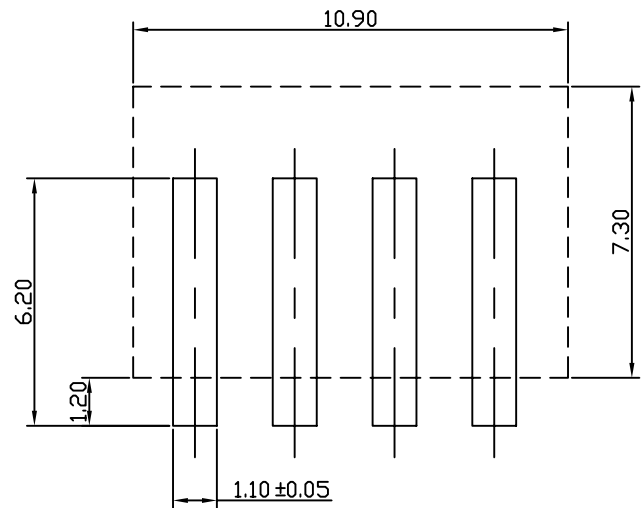

PCB LAYOUT (REF.)

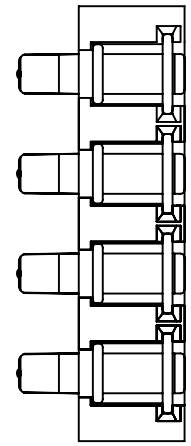
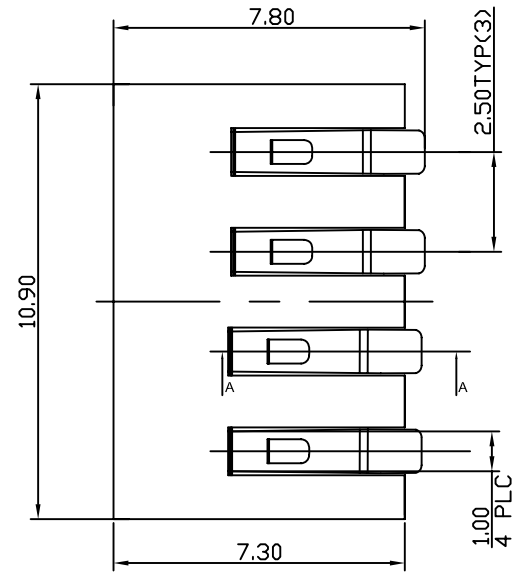
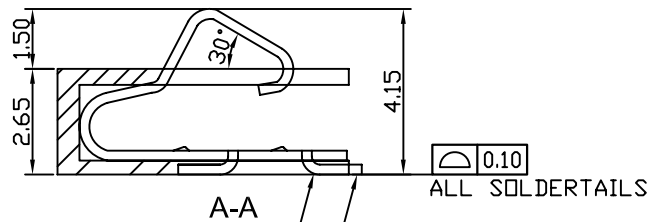

MAX. FROM SETTING PLANE
CONPLANARITY TO BE 0.1 mm
CONTACT TAILS.

NOTES:

- MATERIAL:
HOUSING: LCP UL94V-0, COLOR:BLACK
CONTACT: T=0.2mm. COPPER ALLOY.
- FINISH:
CONTACT: 1μ" MIN. GOLD PLATED ON CONTACT AREA, 80μ" ~ 240μ" BRIGHT-TIN ON
SOLDER TAIL, WITH ENTIRE CONTACT UNDERPLATED 50μ" ~ 150μ" NICKEL.

BAF004004MB0G2X
PART NUMBER

TOLERANCES UNLESS OTHERWISE SPECIFIED: 0 PLC ± - 1 PLC ± 0.2 2 PLC ± 0.1 3 PLC ± - 4 PLC ± - ANGLES ± 3'	DWN JOHN_CHANG 27SEP2008 CHK MARKS_CHEN 27SEP2008 APVD BEST_CHANG 27SEP2008 PRODUCT SPEC	Zhongxiang Electron Science CO.,LTD			
MATERIAL SEE NOTE	APPLICATION SPEC			SIZE A3	DRAWING NO JWGCC005
FINISH SEE NOTE	WEIGHT - GRAMS	BATTERY BLOCK CONNECTOR REEPTACLE ASSY 4PIN 2.5MM PITCH			
PROJECTION	DIMENSIONS: MM	CUSTOMER DRAWING	SCALE -	SHEET 1 of 2	REV A

REV.	DESCRIPTION	DATE	DWN	APVD
A	-	27SEP08	JC	BC

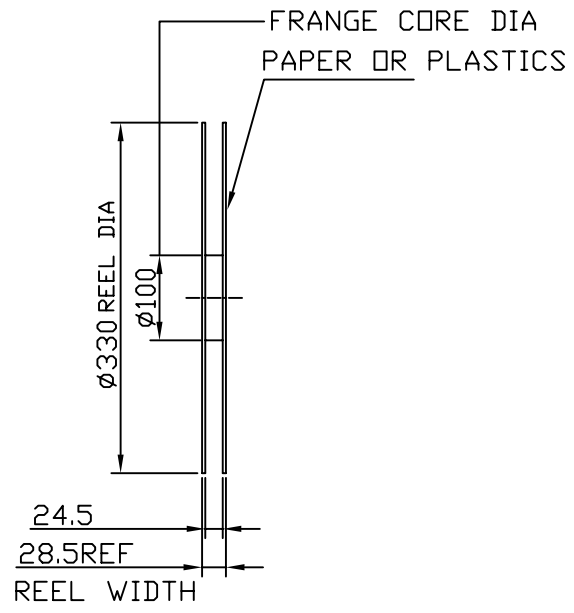

USER DIRECTION OF UNREELING →

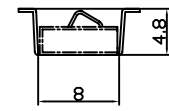
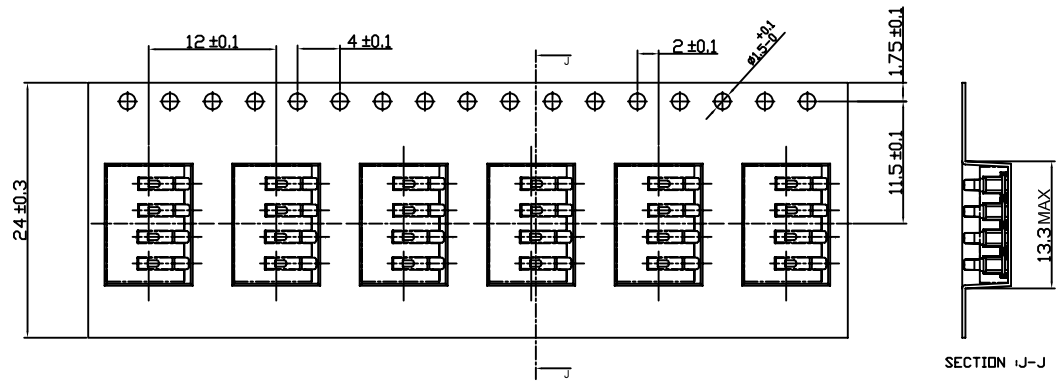

WEEDING THE COVER TAPE
(INCLUDING EMPTU POCKET)

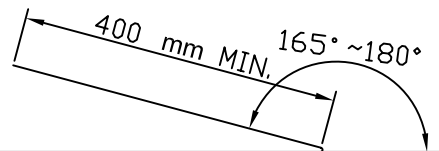

1. PEELING STRENGTH: 0.1~0.13N (10~130 GRAMS)
2. PEELING SPEED: 300mm/min
3. PRODUCT WEIGHT: 0.315 g

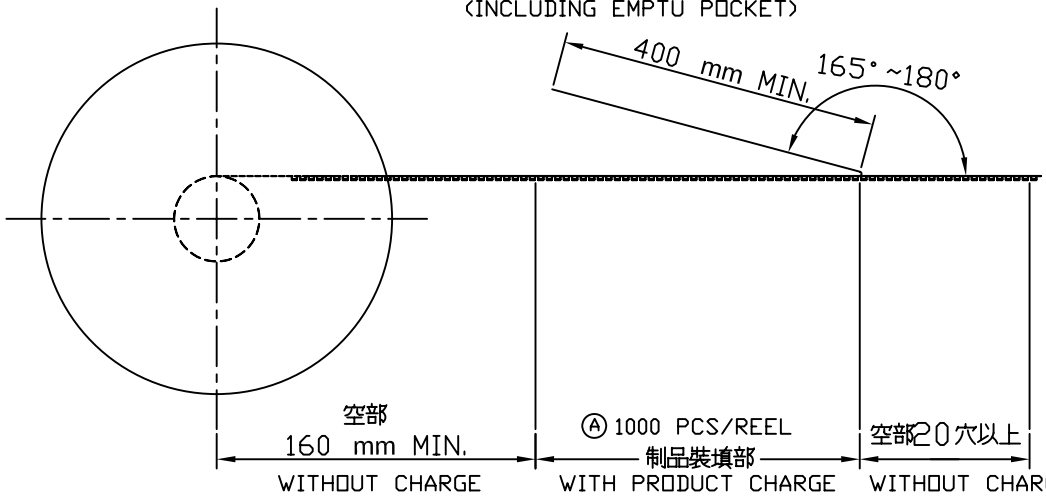

1000	10	10000 PCS	8.8 KG	3.1 KG
PCS/ TAPE	REELS/ BOX	QUANTITY	GROSS WEIGHT	NET WEIGHT

TOLERANCES UNLESS OTHERWISE SPECIFIED: 0 PLC ± - 1 PLC ± 0.2 2 PLC ± 0.1 3 PLC ± - 4 PLC ± - ANGLES ± 3° MATERIAL SEE NOTE FINISH SEE NOTE PROJECTION	DWN JOHN CHANG 27SEP2008	Zhongxiang Electron Science CO.,LTD BATTERY BLOCK CONNECTOR REEPTACLE ASSY 4PIN 2.5MM PITCH			
	CHK MARKS CHEN 27SEP2008				
	APVD BEST CHANG 27SEP2008	NAME	SIZE A3	DRAWING NO JWGCC005	RESTRICTED TO
	PRODUCT SPEC	WEIGHT - GRAMS	DIMENSIONS: MM	CUSTOMER DRAWING	SCALE -

SHEET	2 OF 2	REV	A
-------	--------	-----	---