

REV.	DESCRIPTION	DATE	DWN	APVD
A	RELEASED	20July09	YF	DV

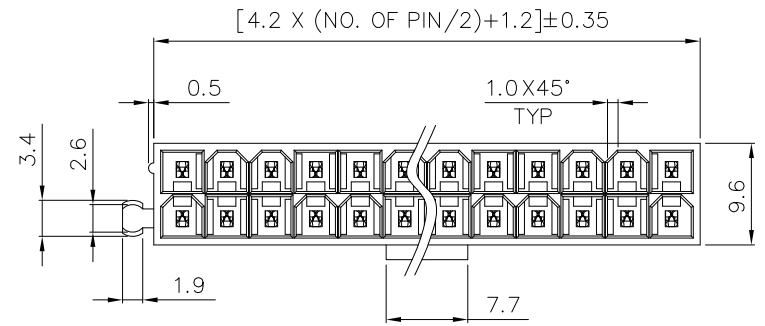

NOTE:
 1.MATERIAL:
 HOUSING: (SEE TABLE), UL94 V-0, WHITE COLOR.
 CONTACTS: BRASS.
 2.FINISH:
 CONTACTS: 100μ" MIN. (SEE TABLE) TIN OVER 50μ" MIN. NICKEL.

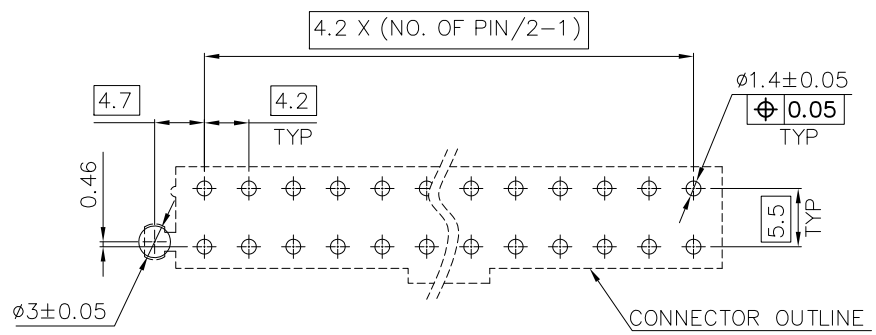
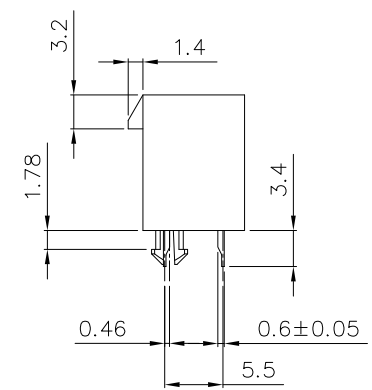
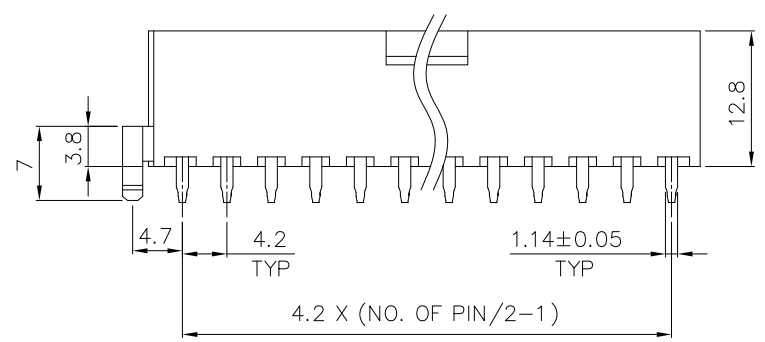

TOLERANCE: ±0.05
 RECOMMENDED PCB LAYOUT
 (TOP VIEW)

2 x 10	AC1412920LWOW7S0	01-0003-02
2 x 4	AC1412908LWOW7S0	01-0003-01
POST NO.	PART NUMBER<OLD>	PART NUMBER

TOLERANCES UNLESS OTHERWISE SPECIFIED:	DWN YONGFENG 20July2009	Zhongxiang Electron Science CO.,LTD	
0 PLC ± -	CHK GAVIN 20July2009		
1 PLC ± 0.3	APVD DAVID 20July2009	NAME	
2 PLC ± 0.2	PRODUCT SPEC JS-GC03140-A1	ATX POWER,DOUBLE ROW, VERTICAL, DIP,TYP.	
3 PLC ± 0.15	APPLICATION SPEC ATX_01-1(A)	SIZE A3	DRAWING NO C-01-0003
4 PLC ± -	ANGLES ± 3'	RESTRICTED TO -	
MATERIAL SEE NOTE	PROJECTION	CUSTOMER DRAWING	SCALE 1:1
FINISH SEE NOTE		SHEET 1 of 1	REV A
DIMENSIONS: mm			

REV.	DESCRIPTION	DATE	DWN	APVD
A	RELEASED	20July09	YF	DV

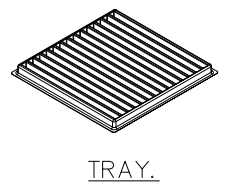
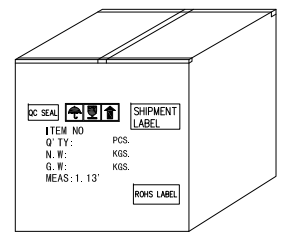
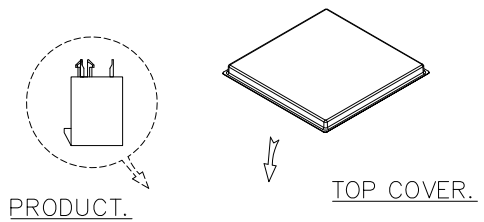

1. DIMENSION:
 TARY: 272*281*19mm
 PE BAG: (340*280)*770
 PARTITION: 546*282mm
 OUTSIDE CARTON: 320*285*395mm.
2. QUANTITY:
 (SEE TABLE)
3. WEIGHT:
 (SEE TABLE)
4. CARTON STACK HEIGHT SHOULD NOT EXCEED 1.3 m.

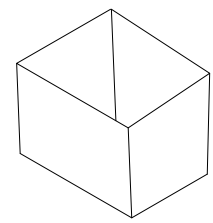
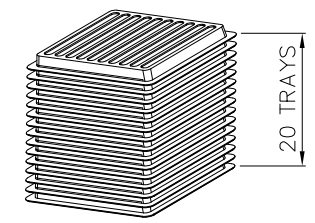
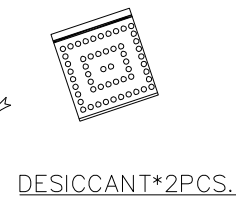
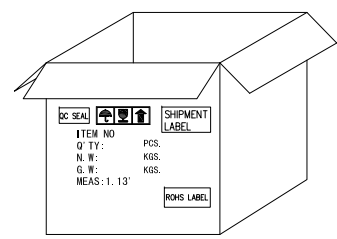
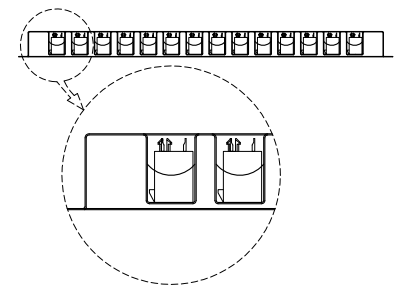

7.8 KG	6.7 KG	1400	154	2 x 10	AC1412920LWOW7S0	01-0003-02
7.4 KG	6.3 KG	3080	70	2 x 4	AC1412908LWOW7S0	01-0003-01
GROSS/WEIGHT	NET/WEIGHT	PCS/CARTON	PCS/TRAY	POST NO.	PART NUMBER(OLD)	PART NUMBER

TOLERANCES UNLESS OTHERWISE SPECIFIED:		DWN YONGFENG		Zhongxiang Electron Science CO.,LTD	
0 PLC ± -	CHK	20July2009			
1 PLC ± 0.3	GAVIN		NAME		
2 PLC ± 0.2	APVD		DAVID		
3 PLC ± 0.15	PRODUCT SPEC		PACKING INSTRUCTION		
4 PLC ± -	APPLICATION SPEC		DRAWINGS OF ATX POWER		
ANGLES ± 3'	FINISH SEE NOTE		SIZE DRAWING NO		
MATERIAL SEE NOTE	PROJECTON		A3 PK-01-0003		
WEIGHT SEE TABLE	DIMENSIONS: MM		CUSTOMER DRAWING		
RESTRICTED TO		SCALE		SHEET 1 of 1	
REV A		REV		REV A	